

Fribay

SIMPLICITY WITH THE GEWISS **QUALITY** THAT CANNOT BE GIVEN UP

Ceiling reflector for discharge lamps with a maximum power of 400 W. Double protection rating: IP 21, of the optical compartment which can be increased up to IP 41 if installed together with protective glass, and IP 41 of the electrical accessories compartment.

Casing made of steel with polyester paint grey RAL 7035. Possibility to install in false ceilings for lamps with power up to 250 W. Reflector made of aluminium 99.85 polished and anodized in symmetrical and asymmetrical versions.

Steel backplate can be removed to make installing the product on the ceiling easy. Also available in the version with auxiliary halogen lamp to guarantee the light flux even in the event of a brief power failure.



FRIBAY RANGE

CEILING-MOUNTING REFLECTORS



CHARACTERISTICS AND ADVANTAGES

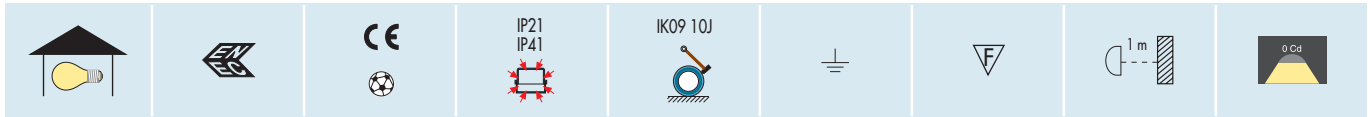

BACKPLATE

With the backplate it is now possible to quickly install the reflector. installation can comfortably be done even by just one person. The backplate is fitted with 6 pre-opened cable entries \varnothing 24 mm so rigid or flexible conduits can be inserted directly.

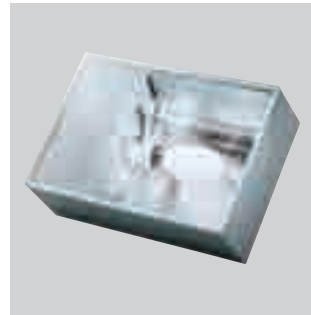

AUXILIARY HALOGEN LAMP

Versions with auxiliary halogen lamp for immediate ignition of the light, even following a power failure. When the main discharge source once again reaches normal operation, the auxiliary lamp automatically switches off.

FRIBAY RANGE

FALSE CEILINGS

By using the frame, it is possible to install the versions with lamps having a maximum power of 250 W in false ceilings.

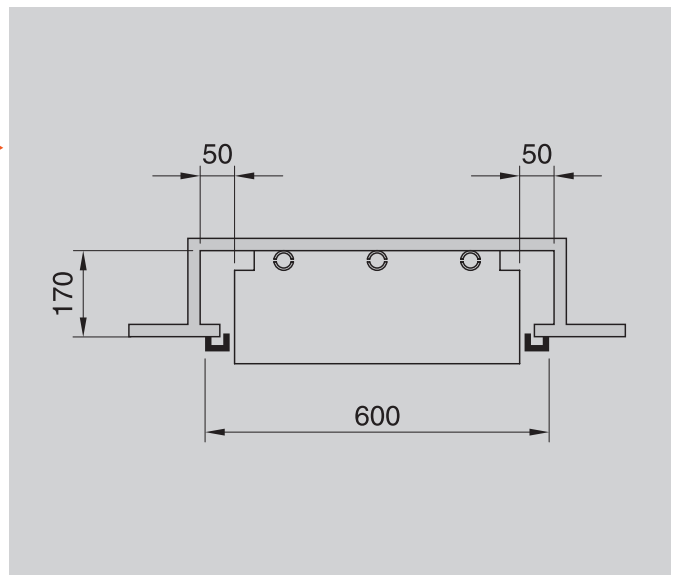
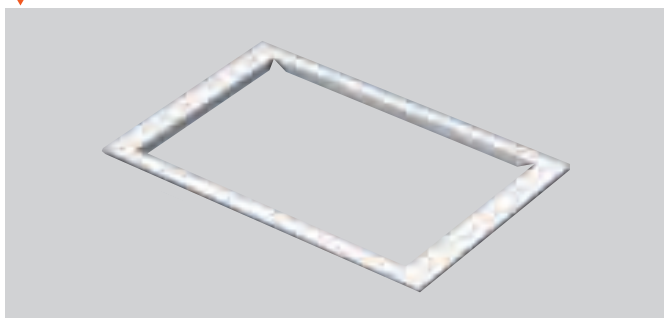

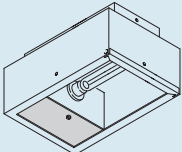
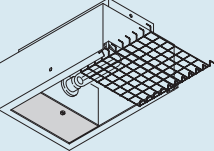
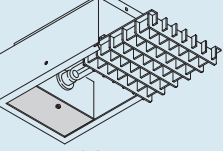
	OPTICAL COMPARTMENT	ACCESSORIES COMPARTMENT
 With glass	IP41	IP41
 with wire guard	IP21	IP41
 with louvre	IP21	IP41

Note: the wire guard and louvre cannot be mounted at the same time.

ACCESSORIES FOR THE OPTICAL COMPARTMENT

The optical compartment can be closed with a wire guard, glass or louvre. FRIBAY has a double standardized guide that is accessible through a rotating door so any accessory can be put inside.

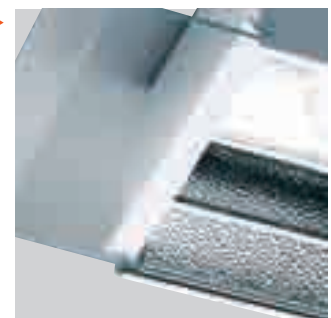

MAINTENANCE

Maintenance is remarkably simplified thanks to the door that slides on guides and rotation of the wiring plate after the product is installed so as to easily gain access to the electric components.